

**SIEMENS**

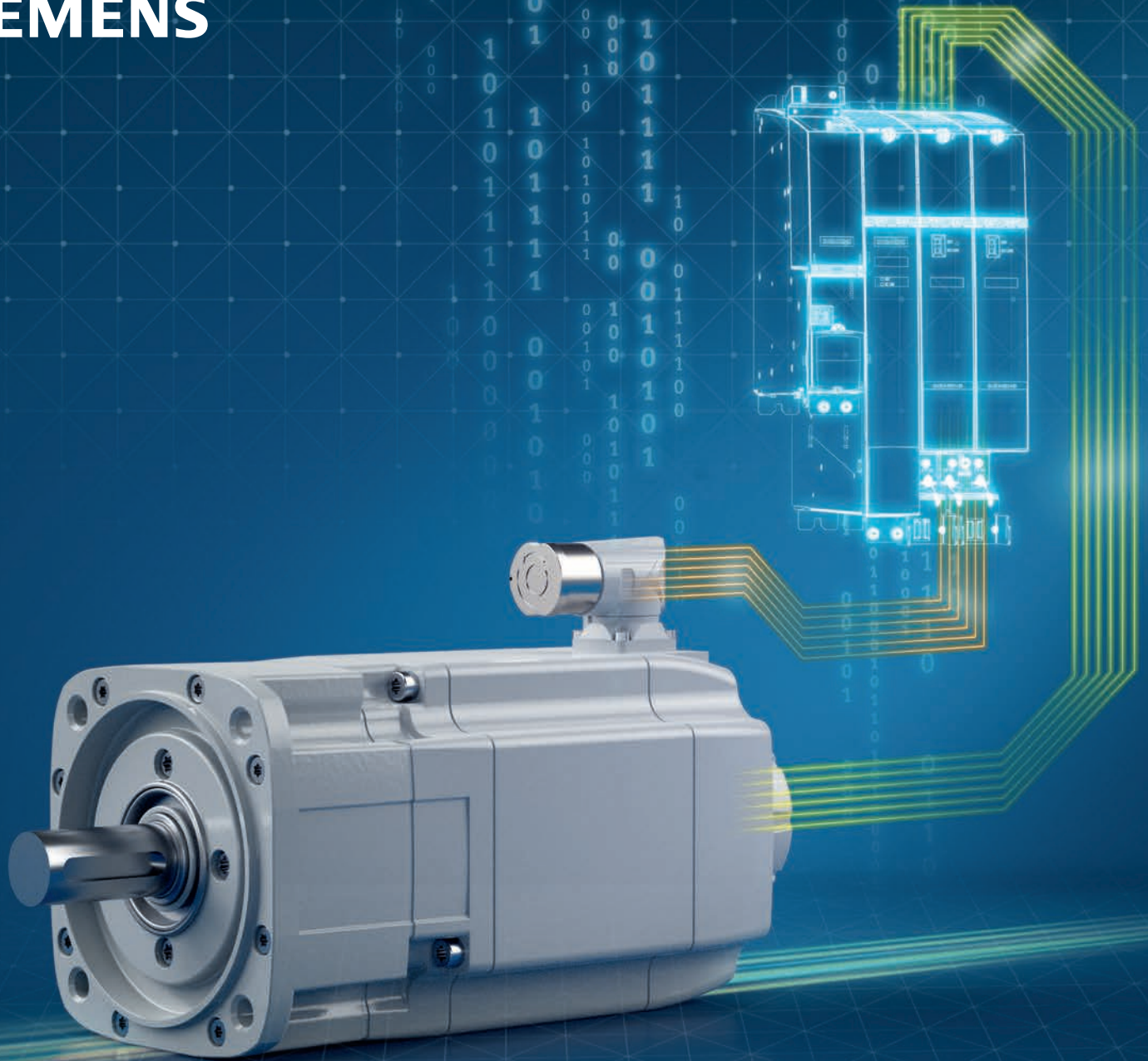

**SIMOTICS**

compact, dynamic and rugged

Experience a higher level of precision

[usa.siemens.com/motion-control-motors](http://usa.siemens.com/motion-control-motors)

# **SIMOTICS motors** for every motion control application





## Contents

- 04 **Move it!**
- 06 **Servomotors for every motion application**  
SIMOTICS S-1FK7
- 08 **SIMOTICS-S servomotors**  
SIMOTICS S-1FT7
- 10 **SIMOTICS-S servo geared motors**  
SIMOTICS S-1FG1
- 12 **Our servo-drive systems can be simply engineered for your application**  
SIMOTICS S-1FL6 and SINAMICS V90  
SIMOTICS S-1FK2/1FT2/1FS2 and SINAMICS S210
- 14 **Main motors with outstanding performance up to 40,000 rpm**  
SIMOTICS M-1PH8  
SIMOTICS M-1FE
- 18 **SIMOTICS linear motors—the benchmark for directly driving linear axes**  
SIMOTICS L-1FN3
- 20 **SIMOTICS torque motors—always providing the right spin at precisely the right time**  
SIMOTICS T-1FW3  
SIMOTICS T-1FW6
- 22 **MOTION-CONNECT connection system**
- 23 **DRIVE-CLiQ plug-and-play commissioning**
- 24 **SIZER, DT Configurator and CAD CREATOR**
- 25 **Mechatronic Support**
- 26 **SIMOTICS motion control motors—an overview**

# | Move it!

Since the development of the dynamo-electric principle by Werner von Siemens in 1866, innovative motor technology represents a core business of our company. In addition to low-voltage, DC and high-voltage motors, **SIMOTICS motors** have firmly established themselves in many industries when it comes to addressing demanding motion control applications.

## **The correct solution**

Whether for precise and repeatable positioning, constant speed and high dynamic motion, long traversing paths or fast velocity changes—the **Siemens SIMOTICS portfolio of servo, main, linear and torque motors** has the optimum solution for every motion control application.

### **SIMOTICS motion control motors are based upon:**

- More than 150 years of experience and innovation in electric motor technology
- The widest range of motors worldwide with optimum solutions for motion control applications in every manufacturing industry and power class
- Can be fully integrated into the drive-train to create overall systems, perfectly addressing the control concept
- Rugged and compact design for reliable, low-maintenance operation with the highest dynamic performance and precision
- A global network of skill sets and worldwide service around the clock

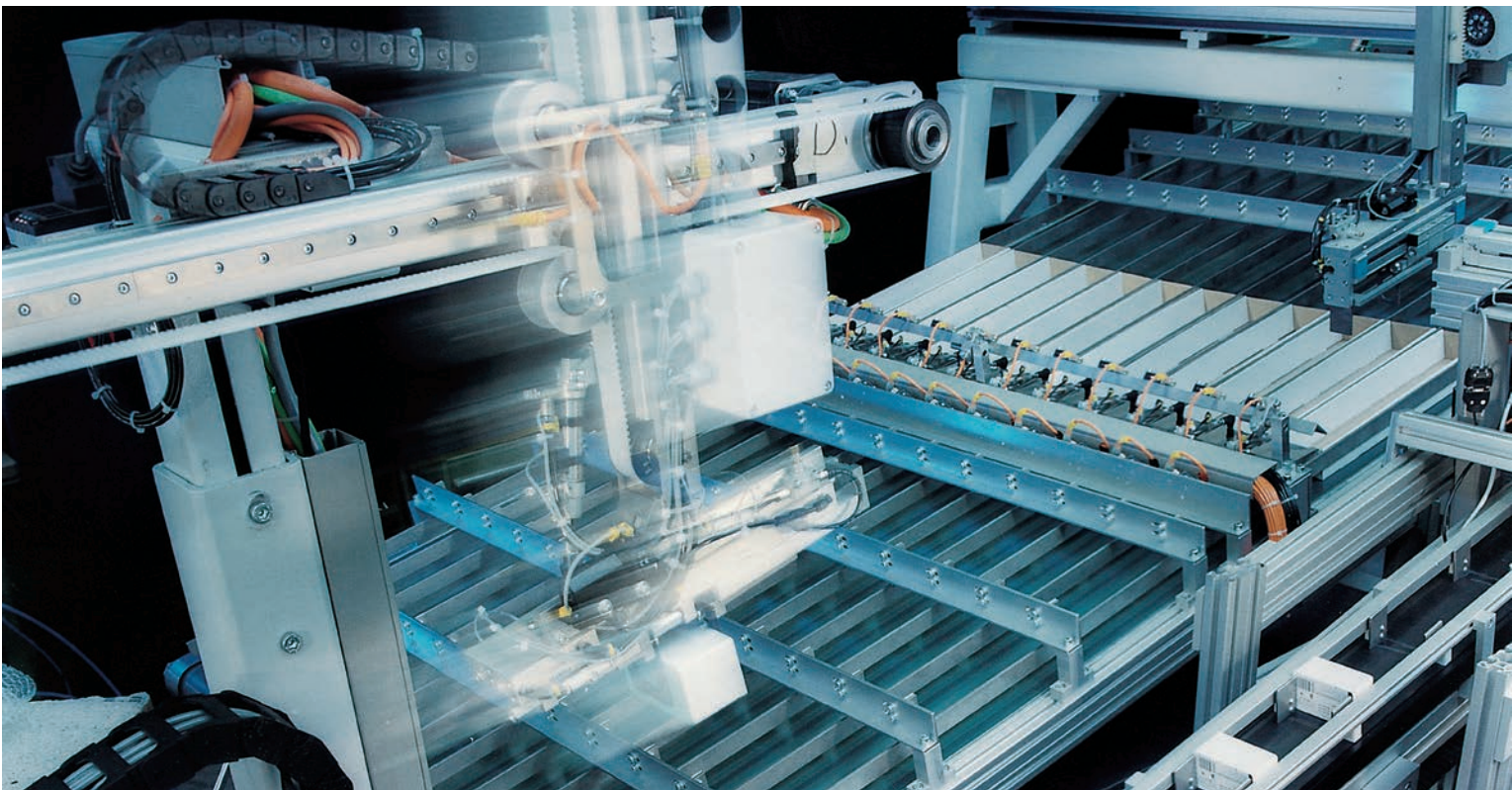

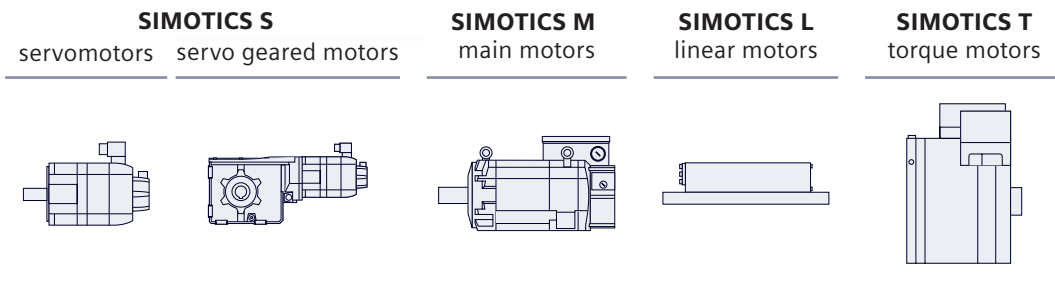

**SIMOTICS motion control motors** are perfectly harmonized and coordinated for operation with our SINAMICS family of drives. This simplifies the engineering and commissioning needed for high-performance applications in machine building and plant construction.

**Optimum integration in the drive and control system**

To optimize interaction with the drive, Siemens motors have a DRIVE-CLiQ interface to quickly transfer data—and transparently monitor important motor information. In addition, SIMOTICS motion control motors operate perfectly with SIMATIC, SINUMERIK and SIMOTION control systems from Siemens.

For specific questions related to your application, simply e-mail us: [✉ mc.us@siemens.com](mailto:mc.us@siemens.com)

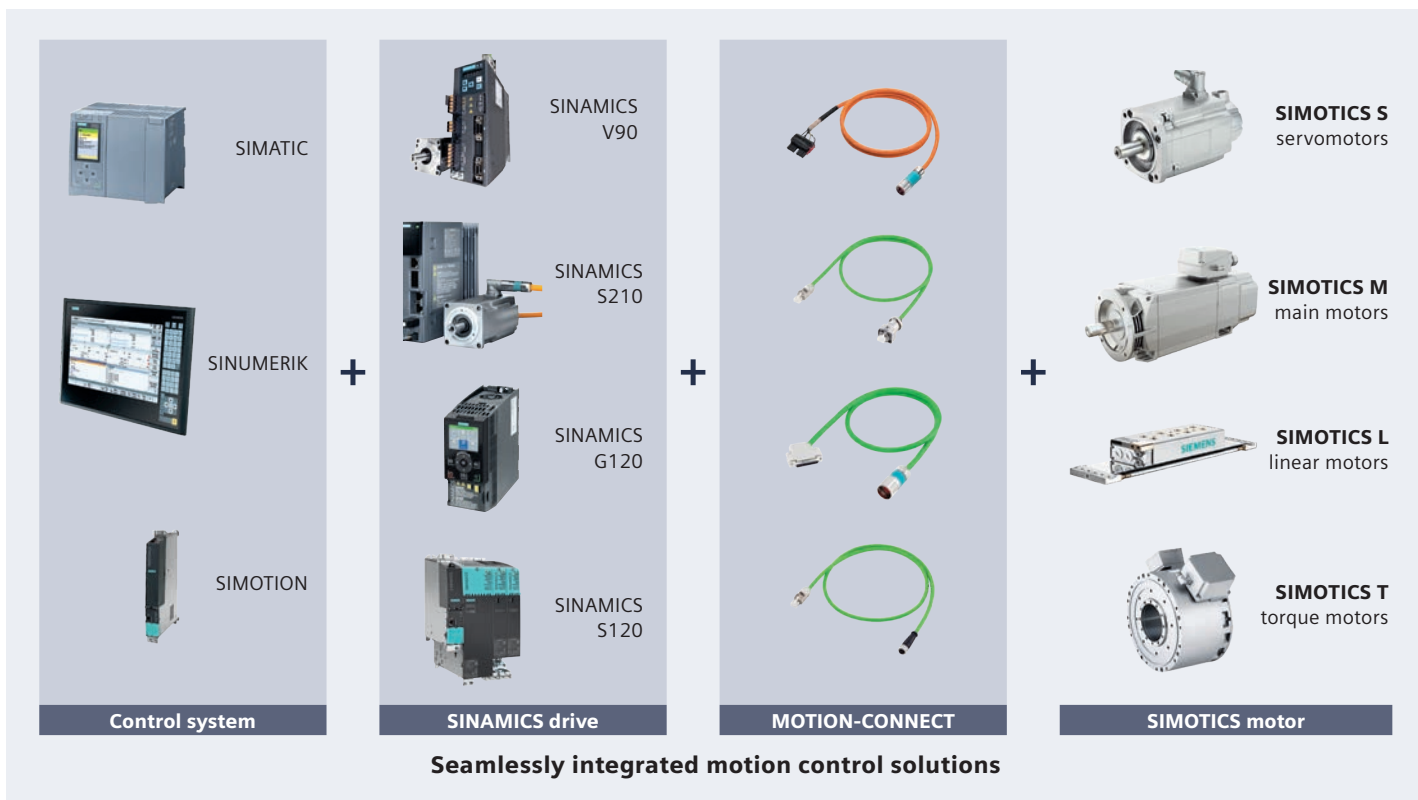

# | Servomotors for every motion application

No matter whether positioning, angular synchronism, cyclic drives or path control in CNC machines—with SIMOTICS servomotors, you benefit from high dynamic performance, precision, compactness and ruggedness.

## SIMOTICS S-1FK7

### Highlights

---

3 versions with different moment of inertia versions—Compact, High Dynamic, High Inertia

---

High efficiency 300% overload capability

---

Resistant to shock and vibration—the encoder is mechanically decoupled

---

Optional absolute encoder, incremental encoder or resolver

---

Installation and service-friendly using a rotatable quick-release connector and field-replaceable encoder

---

Digital DRIVE-CLiQ interface with electronic type plate for optimal connectivity to SINAMICS S120 drives

---

Optionally with different types of gearboxes and backlash-free holding brake

---

Cooling methods—natural cooling and forced ventilation

---

### Typical application areas

- Packaging machines
  - Plastics and textile machines
  - Digital printing machines
  - Wood, glass, ceramic and stone processing machines
  - Robots, handling systems and conveyor technology
  - Feed and auxiliary axes for CNC machines
- 

### Cost-efficient, flexible and universal

With our SIMOTICS S-1FK7 servomotors, depending upon the requirements relating to dynamic performance, control response, precision and space, there are three moment-of-inertia versions to select from—when required, also in combination with a gearbox.

#### SIMOTICS S-1FK7 Compact (CT)

High power density with a short length makes our SIMOTICS S-1FK7 Compact (CT) motors the clear choice for universal use in applications where space is restricted.

#### SIMOTICS S-1FK7 High Dynamic (HD)

These motors set themselves apart as a result of their low rotor diameter. This minimizes the intrinsic moment of inertia and facilitates high-dynamic performance. This also makes them ideal when it comes to motion sequences with very short cycle times demanding high-dynamic performance.

#### SIMOTICS S-1FK7 High Inertia (HI)

The increased intrinsic moment of inertia of our SIMOTICS S-1FK7 High Inertia (HI) motors ensures an extremely rugged control response—ideal for applications with high and variable load moments of inertia.

#### SIMOTICS S-1FK7 with mounted planetary gearbox

When specified, we can also supply S-1FK7 motors with a mounted planetary gearbox. High-precision and economic planetary gearboxes are available to address a wide range of applications. You benefit from high, smooth-running properties and compactness for motion control applications.

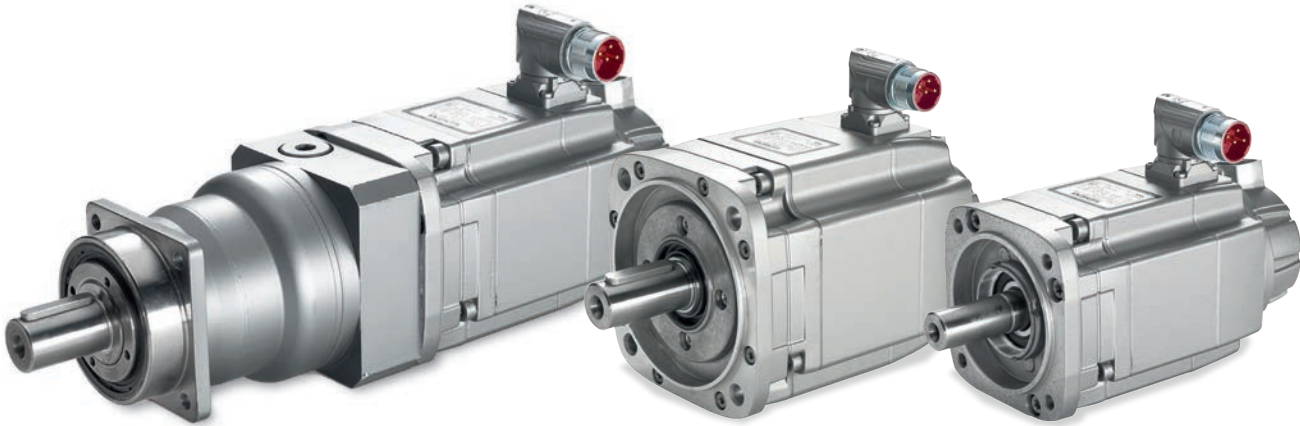

### SIMOTICS S-1FK7 servomotors—overview

SIMOTICS S-1FK7	Standstill torque *	Rated speed *	Rated power *
CT—Compact	0.2–48 Nm	up to 6,000 rpm	0.05–8.2 kW
HD—High Dynamic	1.3–28 Nm	up to 6,000 rpm	0.6–3.8 kW
HI—High Inertia	3–48 Nm	up to 6,000 rpm	0.9–7.7 kW

\* depending upon the version and type

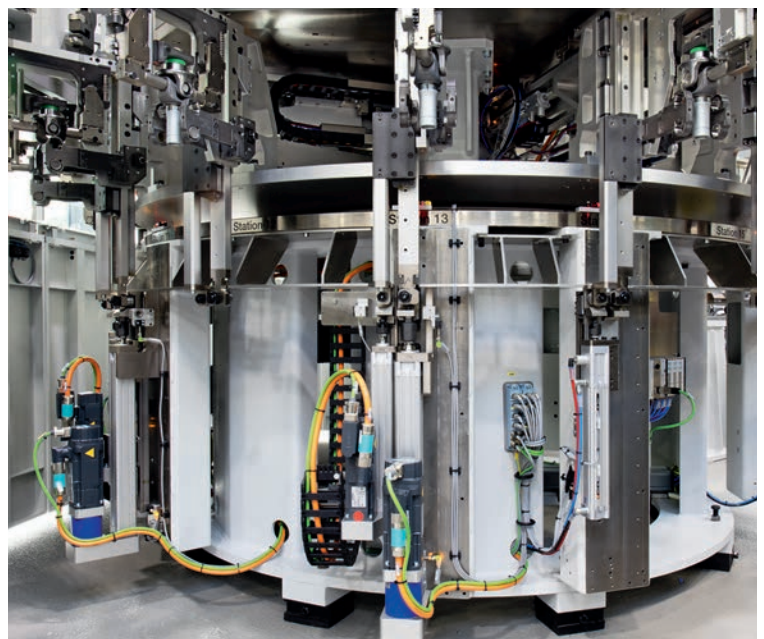
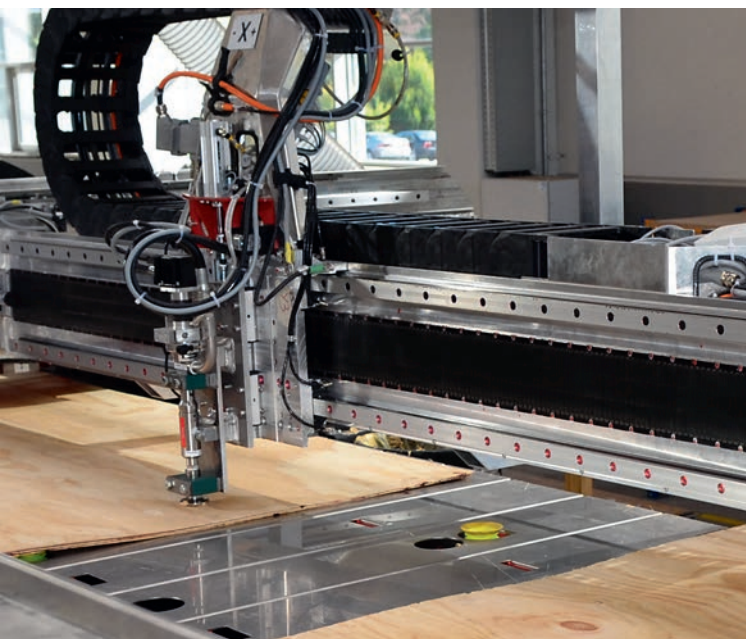

# | SIMOTICS-S servomotors

## SIMOTICS S-1FT7

### Highlights

---

Two versions with different moments of inertia—  
Compact, High Dynamic

---

High efficiency and 400% overload capability  
(naturally cooled versions)

---

High surface quality of the workpiece through low radial  
eccentricity and low torque ripple

---

Either naturally-cooled, forced-ventilated or water-cooled

---

IP67 degree of protection makes them extremely  
rugged—and encoders are mounted so they are  
decoupled from any oscillation and vibration

---

Optional absolute encoder or incremental encoder

---

Service- and installation-friendly using the crossover profile,  
quick release connector that can be rotated and field-  
replaceable encoder

---

Digital DRIVE-CLiQ interface with electronic type plate  
for optimum connectivity to SINAMICS S120 drives

---

Optional: holding brake with no backlash—and planetary  
gearbox with low backlash

---

### Typical application areas

---

- CNC machine tools
  - Packaging machines
  - Plastics and textile machines
  - Digital printing machines
  - Conveyor technology and handling systems
  - Wood, glass, ceramic and stone processing machines
- 

### Maximum power and performance with customized cooling and high efficiency

Our SIMOTICS S-1FT7 servomotors are completely in their element when it comes to high-performance motion control applications in the torque range up to 280 Nm. They are available in two, highly-efficient versions with various cooling methods.

### SIMOTICS S-1FT7 Compact motors (CT)

Naturally cooled, force-ventilated or water-cooled 1FT7 motors are predominantly used where space is restricted and a high power density is required. Their low torque ripple makes them ideal for machine tool applications where high surface quality finish is very critical.

### SIMOTICS S-1FT7 High Dynamic motors (HD)

This version sets itself apart as a result of the extremely low intrinsic moment of inertia. This makes them the clear choice for applications demanding the highest dynamic response and shortest cycle times. 1FT7 High Dynamic motors are available with forced ventilation and water cooling—and are characterized by their high continuous power capability.

### SIMOTICS S-1FT7 with mounted planetary gearboxes

When specified, we can also provide S-1FT7 motors with mounted planetary gearboxes. High-precision planetary gearboxes are available to address a wide range of applications. With these motors, you benefit from high, smooth-running properties and a high degree of compactness for motion control applications.



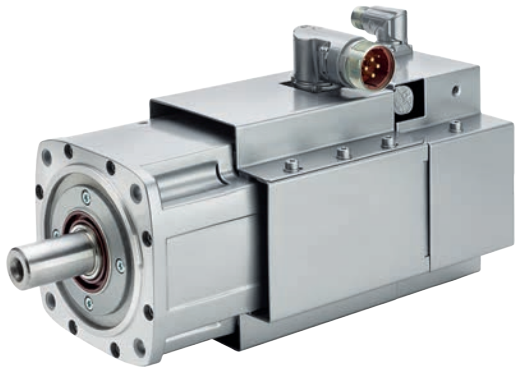

Forced ventilation

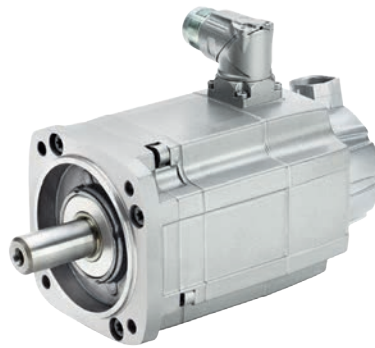

Natural cooling

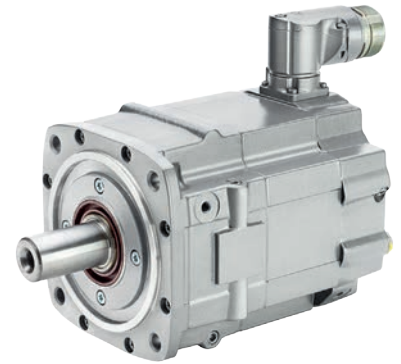

Water cooling

**SIMOTICS S-1FK7 servomotors—overview**

SIMOTICS S-1FK7	Standstill torque *	Rated speed *	Rated power *
CT—Compact	2–280 Nm	up to 6,000 rpm	0.88–45.5 kW
HD—High Dynamic	14–105 Nm	up to 4,500 rpm	3.8–21.7 kW

\* depending upon the version and type

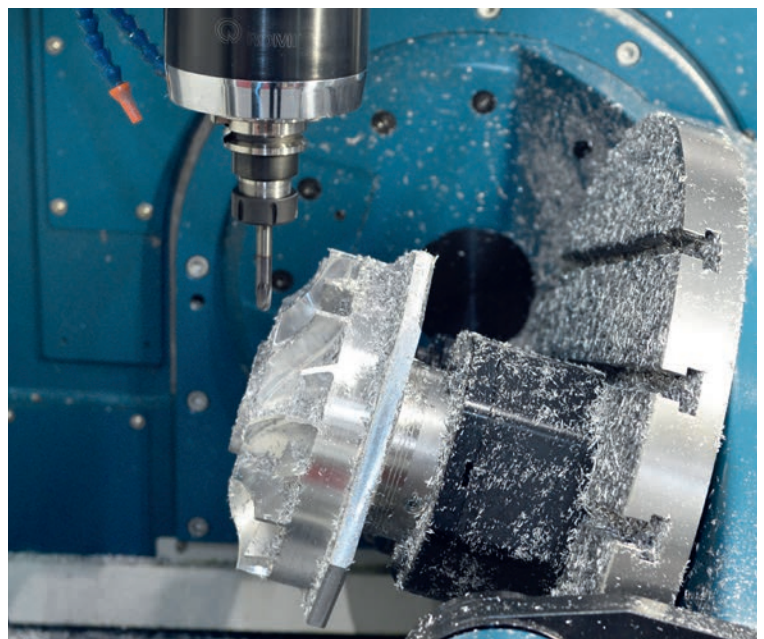

# SIMOTICS-S servo geared motors

## SIMOTICS S-1FG1

### Highlights

Versions for standard (Compact) and especially fast load cycles (High Dynamic)

Naturally cooled design with a high power density

Helical gearing for very smooth operation

Wide range of versions based on four gearbox types and up to 25 ratios

High transmission ratio in the first gearbox stage allows two instead of three stage gearboxes to be used—resulting in a two percent higher efficiency with lower temperature rise

Digital DRIVE-CLiQ interface with electronic type plate for optimum connectivity to SINAMICS S120 drives

### Typical application areas

- Packaging machines
- Printing machines
- Wood and metal processing
- Palletizers and storage and retrieval machines with hoisting, gantry and fork drives
- Dosing pumps and actuator drives

### Open for a wide range of gearboxes

The concept of our SIMOTICS S-1FG1 servo geared motors is attractive as a result of the variable configuration options that can be used to create customized solutions—both regarding the type of construction and power rating. Irrespective of whether your application requires a helical, parallel shaft, bevel or helical worm gearbox, with high efficiencies, low torsional backlash and finely graduated ratios, these motors can optimally address a wide range of different motion control applications.

### Optimum interaction

These servo geared motors are optimally adapted to the SINAMICS S120 drive system and the various commissioning tools. This facilitates seamless integration into the drive and automation environment.

Commissioning can be performed very quickly using the DRIVE-CLiQ system and electronic type plate. Pre-fabricated MOTION-CONNECT power and signal cables ensure that perfect connections can be established quickly and easily.

## SIMOTICS S-1FG1 servo geared motors—overview

Geared motor type	Helical <sup>1)</sup>	Parallel shaft <sup>1)</sup>	Bevel <sup>2)</sup>	Helical worm <sup>3)</sup>
Gearbox designation	Z29–Z129 D29–D129	FZ29–FZ129 FD29–FD129	B29–B49 K39–K149	C29–C89
Max. drive torque (Nm)	14–1,890 (Z) 146–5,000 (D)	17–5,000 (FZ) 163–5,010 (FD)	15–465 (B) 24–8,160 (K)	46–1,480
Range of transmission ratios	3.4–62.5 (Z) 39.3–373 (D)	3.6–65.2 (FZ) 46.4–413 (FD)	3.5–59.3 (B) 5.2–244.3 (K)	6.2–102.5

<sup>1)</sup> 2-stage (Z), 3-stage (FD) <sup>2)</sup> 2-stage (B), 3-stage (K) <sup>3)</sup> 2-stage

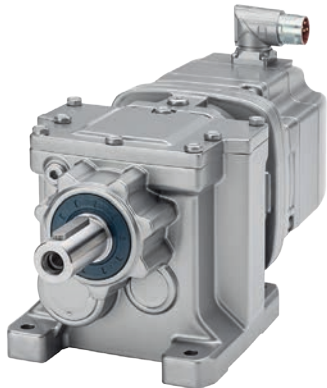

Helical geared motor

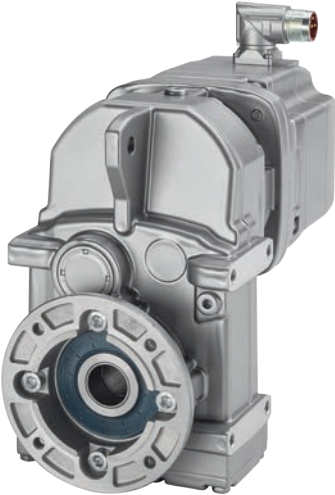

Parallel shaft geared motor

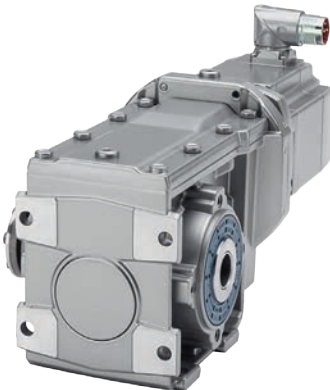

Bevel geared motor

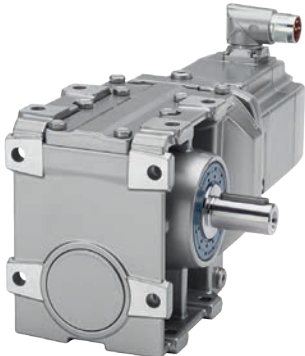

Helical worm geared motor



# Our servo-drive systems can be simply engineered for your application

## SIMOTICS S-1FL6 and SINAMICS V90

### Highlights

Two versions with different moments of inertia—Low and High Inertia

300% overload capability and high IP65 degree of protection

With either incremental or absolute encoder

Quick release connector for simple motor installation

Servo tuning and machine optimization using the auto-tuning function

All frame sizes have an integrated braking resistor

Optional with / without brake—as well as with plain shaft or feather key



### Typical application areas

- Handling systems, automatic equipping and assembly machines
- Packaging and labeling machines
- Metal-forming machines
- Printing machines
- Winders and unwinders

### Can be flexibly configured in the lower power range

Together with SINAMICS V90 drives, SIMOTICS S-1FL6 servomotors form a seamlessly integrated drive system with eight drive sizes and seven motor versions. Based upon their optimized moment of inertia, the motors handle continuous motion such as winding and punching—with very high, smooth running characteristics. Versions with a very low moment of inertia are available for motion sequences demanding a high dynamic performance with high positioning accuracy.

### SIMOTICS S-1FL6 servomotors—overview

SIMOTICS S-1FL6	Standstill torque *	Rated speed *	Rated power *
LI—Low Inertia	0.16–6.37 Nm	up to 5,000 rpm	0.05 – 2.0 kW
HI—High Inertia	1.27–33.4 Nm	up to 3,000 rpm	0.4 – 7.0 kW

\* depending upon the version and type



## SIMOTICS S-1FK2/1FT2/1FS2 and SINAMICS S210

### Highlights

Two versions with different moments of inertia—  
Compact and High Dynamic

High efficiency and 300% overload capability

With either multi-turn absolute or absolute encoder

Extremely simple to commission with web-server, motor parameters are automatically read in—and the drive system can be perfectly optimized using the One Button Tuning function

One Cable Connection (OCC) to connect the motor to the drive



### Typical application areas

- Packaging machines and filling systems
- Feeding, removing, mounting and stacking systems
- Wood, glass, ceramic and stone processing machines
- Digital printing machines
- Plastics and textile machines
- CNC machine tools
- Robots and handling systems

### Perfect interaction to address high requirements

SIMOTICS S-1FK2 motors have been specifically developed for use with SINAMICS S210 drives—to create a servo-drive system with five power classes from 50 up to 6,400 watts. This means that low loads can be moved with an extremely high dynamic response and high loads can be positioned with a high degree of precision. Motors are connected to the drives through an innovative connection system called One Cable Connection—OCC with quick release. This combines power conductors, encoder signal and brake in one thin cable along with a single, compact plug connector that can be rotated—simplifying installation and increasing drive ruggedness.

### SIMOTICS S-1FK2 servomotors—overview

SIMOTICS S-1FK2	Standstill torque *	Rated speed *	Rated power *
CT—Compact	0.64–40 Nm	3,000 rpm	0.2–6.4 kW
HD—High Dynamic	0.16–16 Nm	3,000 rpm	0.05–3.3 kW

\* depending upon the version and type

#### Note:

1. SIMOTICS S-1FT2 servomotors have similar overview data with additional options.
2. SIMOTICS S-1FS2 servomotors are available with food grade stainless steel shaft/housing and no edges.  
Degree of protection for housing IP69K (max 30 bar). Suitable for Cleaning in Place (CIP).  
Standstill torque 3–23 Nm    Rated speed up to 3,000 rpm    Rated power 0.8–2.5 kW



# Main motors with outstanding performance up to 40,000 rpm

## SIMOTICS M-1PH8

### Highlights

---

Extended power range from 2.8 kW to 1,340 kW

---

Flexible configuration options

- Induction, synchronous or reluctance motor versions
  - Force-ventilated or water-cooled
  - Solid or hollow shaft
  - Wide range of bearing concepts
  - Various encoder types for closed-loop speed control and high-precision positioning
- 

High smooth-running characteristics and ruggedness thanks to the outstanding true running and low vibration severity at maximum speeds of up to 24,000 rpm

---

High-dynamic performance and short accelerating time

---

Winding switchover (star/delta)

---

Simple and flexible connection system

---

Commissioning using the electronic rating plate via digital DRIVE-CLiQ interface

---

### Typical application areas

#### SIMOTICS M-1PH8 induction motors

- Machine tool spindles
  - Paper and printing machines, winders
  - Hoisting equipment and cranes
  - Wood, glass, ceramics and stone processing machines
  - Test stands
  - Presses
  - Plastics and textile machines
  - Wire-drawing machines
- 

#### SIMOTICS M-1PH8 synchronous motors

- Machine tools
  - Servo-presses and cross-cutters
  - Printing machines
  - Extruders, calenders and rubber injection systems
  - Foil machines and systems producing non-woven fibers
  - Rod mills and cable stranding machines
  - Coiler and winder drives
- 

### Modular power houses

The sophisticated modular design offers various degrees of protection and cooling methods—as well as several options to electrically and mechanically integrate the main motor.

### Whether induction, synchronous or reluctance, it's always SIMOTICS

SIMOTICS M-1PH8 induction motors are the ideal choice for applications where—in addition to the higher drive power—the primary focus is on precise, smooth-running characteristics and precise controllability of the axes. Additionally, you can operate them together with SINAMICS G120 drives which, when compared to standard main motors, extends the applications that they can realize as a result of the wider speed range. This allows them to address new, more compact machine concepts.

When the focus is on high-rated torque, our compact SIMOTICS M-1PH8 synchronous motors have unbeatable smooth-running operation. With a wide range of options, they can be flexibly adapted to every application, and are available with forced ventilation as well as with water cooling. This is a typical requirement for machine tools and printing machines—but also for servo-presses, rod mills and more.

Application-specific advantages of reluctance motor versions include:

- Unchanged dimensions and interfaces
- High torque density
- Low rotor inertia
- High efficiency within large torque vs. speed range
- Encoderless or with encoder
- System release for SINAMICS G120 and S120 drives

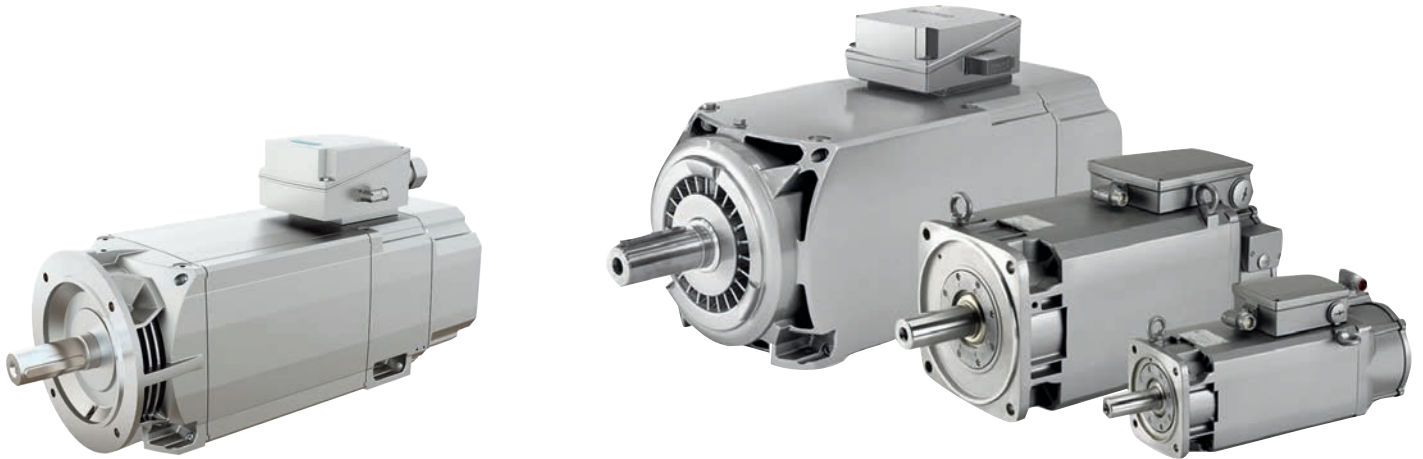

### SIMOTICS M-1PH8 induction and synchronous main motors—overview

SIMOTICS M-1PH8	Standstill torque *	Rated speed *	Max. speed *	Rated power *
Induction	2.9–12,435 Nm	400–10,000 rpm	up to 24,000 rpm	2.8–1,340 kW
Synchronous	94–approx. 1,650 Nm	700–3,600 rpm	up to 4,500 rpm	15–310 kW
Reluctance	200–450 Nm	1,000–2,800 rpm	up to 3,700 rpm	21–121 kW

\* depending upon the version and type



## SIMOTICS main motors

They are designed to address the increasing demands associated with state-of-the-art machine building and plant construction. Available in rugged induction or synchronous versions, they set themselves apart thanks to their short rise times—and they can even handle extreme load cycles with high speed, torque and positioning precision.





## SIMOTICS M-1FE

### Highlights

Compact design as mechanical components can be eliminated

Short accelerating and braking times

High degree of stiffness for milling spindles based upon the large inner rotor bores (and therefore large shaft diameter)

### Typical application areas

- Turning spindles
- Grinding spindles
- Milling spindles

### SIMOTICS M-1FE main motors—overview

SIMOTICS M-1FE	High speed	High torque
Series	M-1FE1	M-1FE1, M-1FE2
Rated torque*	up to 300 Nm	up to 1,530 Nm
Max. speed*	up to 40,000 rpm	up to 20,000 rpm
Rated power*	6.5–94 kW	4–159 kW

\* depending upon the version and type

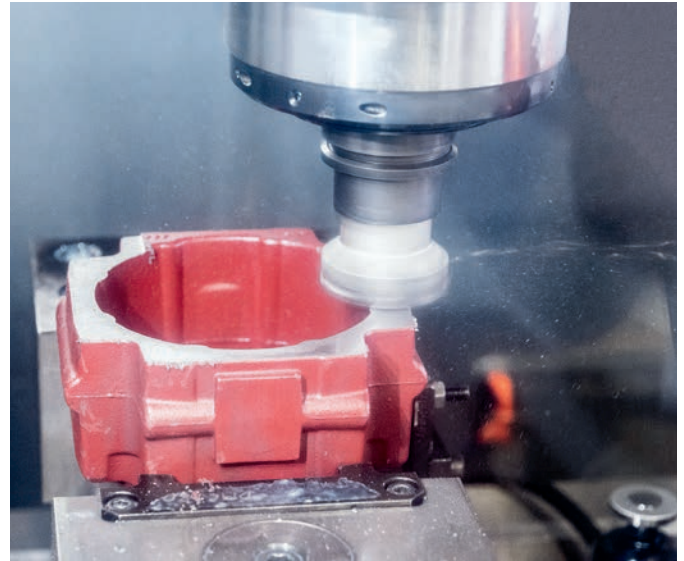

### It has enough space in any spindle

SIMOTICS M-1FE synchronous built-in motors are very compact main spindle motors with a very high-dynamic performance that have been specifically designed for CNC machine tool applications. They set themselves apart as a result of their very high machining quality, short acceleration times, highest precision and smooth running characteristics.

Versions are available for very high torque utilization (High Torque)—or high maximum speeds (High Speed) to address specific applications. The mechanical motor power is directly transferred to the spindle without any mechanical transmission elements. The rotor and stator are ready to be installed and are water-cooled.



# SIMOTICS linear motors—the benchmark for directly driving linear axes

SIMOTICS linear motors set benchmarks when it comes to the accuracy, precision and cost efficiency of linear motion applications. Contrary to conventional drive solutions, they do not require any mechanical transmission elements—which simplifies the design of your machines and optimizes their availability.

## SIMOTICS L-1FN3

### Highlights

- \_\_\_\_\_ Highest precision linear motion with the high-dynamic performance
- \_\_\_\_\_ Enormous force density in a compact design
- \_\_\_\_\_ Highest traversing velocities for all applications
- \_\_\_\_\_ Highest precision when using suitable measuring systems
- \_\_\_\_\_ High energy efficiency
- \_\_\_\_\_ Large air gap, therefore extremely rugged against external influences
- \_\_\_\_\_ Wide range of options depending upon the application profile
- \_\_\_\_\_ Simple mounting and installation
- \_\_\_\_\_ Wear-free drive components
- \_\_\_\_\_ Low machine lifecycle costs

### Typical application areas

- \_\_\_\_\_ ■ Milling, turning and grinding machines
- \_\_\_\_\_ ■ Laser and waterjet machining centers
- \_\_\_\_\_ ■ Handling systems and gantries
- \_\_\_\_\_ ■ Production machines
- \_\_\_\_\_ ■ Oscillators
- \_\_\_\_\_ ■ Test setups

### The manufacturing industry's standard

SIMOTICS L-1FN3 motors are water-cooled and were specifically developed for CNC machine tool applications. They have been the proven standard for linear motion control for many years. The modular principle provides you with a comprehensive range of motor versions that are almost wear-free and therefore low-maintenance. 1FN3 linear motors are available in several different widths and up to five different lengths—as well as several winding types.

The motors are harmonized and coordinated for operation with SINAMICS S120 drives. A wide range of accessories is available to further optimize the high degree of ruggedness and thermal encapsulation.

When it comes to using direct drives in machine tools and production machines, Siemens has many years of experience and a wealth of industry-specific know-how—allowing us to support you by quickly and reliably implementing your development goals.

### SIMOTICS L-1FN3 linear motors—overview

SIMOTICS L-1FN3	Peak load	Continuous load
Feed force*	up to 20,700 N	up to 17,610 N
Velocity*	up to 836 m/min	up to 435 m/min
Overload capability*	up to 2.75 x F <sub>N</sub>	1.7 x F <sub>N</sub>

\* depending upon the version and type



- 1 Primary section
- 2 Precision cooler
- 3 Secondary section
- 4 Secondary section cover
- 5 Cooling profile
- 6 Power cooler
- 7 Connection cover for separate power and signal cables
- 8 Combination adapter



## SIMOTICS torque motors—always providing the right spin at precisely the right time

Whether for machine tools, extruder worms or paper rolls—SIMOTICS slow speed permanent-magnet torque motors represent an attractive solution for driving all rotary axis types. They can be completely integrated into machines without requiring mechanical transmission elements. This reduces the space required, provides maximum flexibility when integrating the motors, minimizes maintenance costs and maximizes availability.

The direct mechanical connection results in an increased dynamic performance and control quality in the overall system and ensures a high torque at the optimum speed with high precision. So depending upon your application, you have the choice between two motor types.

### SIMOTICS T-1FW3 and SIMOTICS T-1FW6

#### Highlights

---

Highest precision, power and dynamic performance

---

Various application-specific versions

---

Direct controllability—no elasticities in the drive train

---

Low space requirement and simplified maintenance as the motor can be directly integrated into the machine structure without having to use mechanical transmission element

---

High number of poles for high torques at low speeds

---

Short acceleration times, extremely high, smooth-running characteristics

---

High degree of efficiency

---

High degree of availability

---

#### Typical application areas

##### SIMOTICS T-1FW3 motors

- Rolling mill drives
- Paper machines
- Plastic injection molding machines
- Handling and assembly systems
- Servo-presses
- Extruders and winders

##### SIMOTICS T-1FW6 motors

- Rotary indexing machines
- Rotary indexing tables and partial machines
- Rotary axes (A/B/C for 5-axis machining centers)
- Workpiece spindles
- Roll and cylinder drives
- Tool turrets

#### SIMOTICS torque motors—the highest precision for rotary axes

The extremely compact, water-cooled SIMOTICS T-1FW3 complete torque motors are flanged to the machine using torque arms specifically developed for the purpose. An optional clamping element makes it easier to couple the rotor to the machine shaft.

The pre-installed mounting set includes the torque arm, clamping element and centering sleeve (only for hollow shafts)—making it simple and safe to establish a connection to the motor. This creates a perfectly stiff drive train that can be optimally controlled.

SIMOTICS T-1FW6 built-in torque motors, stator and rotor are supplied as components and are directly integrated into the machine itself. They are available with jacket as well as with integrated cooling. Additionally, the motors operate without any mechanical transmission elements—e.g. coupling and gearbox—and require significantly less space than conventional drives. The compact design and low number of installed parts reduce the number of interfaces, maintenance costs and stock inventory costs—thus minimizing machine failures.

#### SIMOTICS T-1FW3 and T-1FW6 torque motors—overview

SIMOTICS T	T-1FW3 Complete torque motor	T-1FW6 Built-in torque motor
<b>Rated torque*</b>	up to 7,000 Nm	up to 5,600 Nm
<b>Rated speed*</b>	up to 1,200 rpm	up to 940 rpm
<b>Maximum speed*</b>	up to 1,800 rpm	up to 1,500 rpm
<b>Maximum torque</b>	11,000 Nm	10,900 Nm

\* depending upon the version and type



SIMOTICS T-1FW3

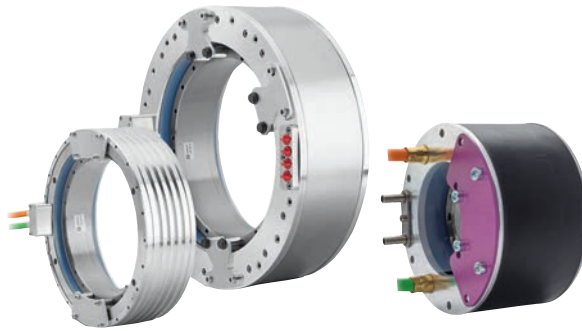

SIMOTICS T-1FW6



# MOTION-CONNECT connection system

With MOTION-CONNECT, Siemens offers a reliable, high-quality and efficient cabling system for your motion control applications. You benefit from higher machine and plant availability thanks to this innovative connection system. It's significantly faster and much easier to connect than conventional systems.

## MOTION-CONNECT

### Highlights

The optimum connection between SINAMICS drives and SIMOTICS motors; plug-and-play based upon system-tested original components

Pre-fabricated cables with rugged IP67 connectors

Cables pre-fabricated with decimeter accuracy

Large selection based upon the finely graduated cross-sections from 1.5 up to 120 mm<sup>2</sup>

Consistent quality management and a comprehensive testing program

Highest plant/system availability and high EMC quality using a 360° shield connection

### The simple fast and reliable connection

- **MOTION-CONNECT 500**—cost-effective product for predominantly fixed cable routing
- **MOTION-CONNECT 800PLUS**— for high-dynamic performance in drag chains with increased mechanical requirements up to 5 g or longer traversing distances up to 50 m
- **SPEED-CONNECT**—fast, rugged and reliable connection using robust round connectors with quick release
- **DRIVE-CLiQ**—high-quality shielded cables with RJ45 metal connector or compact and rugged M12 connector for connecting direct measuring systems

### Technical overview of MOTION-CONNECT

Product	Type	Max. traversing velocity [m/min]		Max. bending operations* [millions]		Max. acceleration* [m/s <sup>2</sup> ]		Max. traversing distance* [m]	
		0–30		0–0.1		0–2		0–5	
MC500	Power cable	0–30		0–0.1		0–2		0–5	
	Signal cable	0–30		0–0.1		0–2		0–5	
MC800 PLUS	Power cable <sup>1</sup> and signal cable	0–300		0–10		0–50		0–50	
	Power cable <sup>2</sup>	0–300		0–10		0–50		0–50	

\* mechanically tested <sup>1</sup>(up to 16 mm<sup>2</sup>) <sup>2</sup>(25 to 50 mm<sup>2</sup>)

# DRIVE-CLiQ plug-and-play commissioning

DRIVE-CLiQ offers some significant advantages while the motor is operational. Transferring actual operating data allows machines and plants to be monitored more transparently.

## DRIVE-CLiQ

### Highlights

High-performance connectivity interface for the SINAMICS drive system

Encoders from various manufacturers can be connected

Integrated safety functions are supported (SINAMICS Safety Integrated)

Auto-configuration based upon electronic rating plates

Simple standard cabling for all encoder types

Hubs are used to reduce cable connections

Low engineering costs

Simple and fast diagnostics of the measuring system

### Increased transparency when it comes to motor monitoring

As the digital interface for SIMOTICS motors, DRIVE-CLiQ uses an Ethernet-based format for fast encoder and motor data transfers between the motor and drive. The motor and encoder electronic type plate are identified in the SINAMICS drive system via this connection—thus facilitating automatic parameterization. This results in fast and simple commissioning.

### SINAMICS S120 booksize group Configuration schematic

- 1 Control Unit
- 2 Line Module
- 3 Double Motor Module
- 4 Single Motor Module

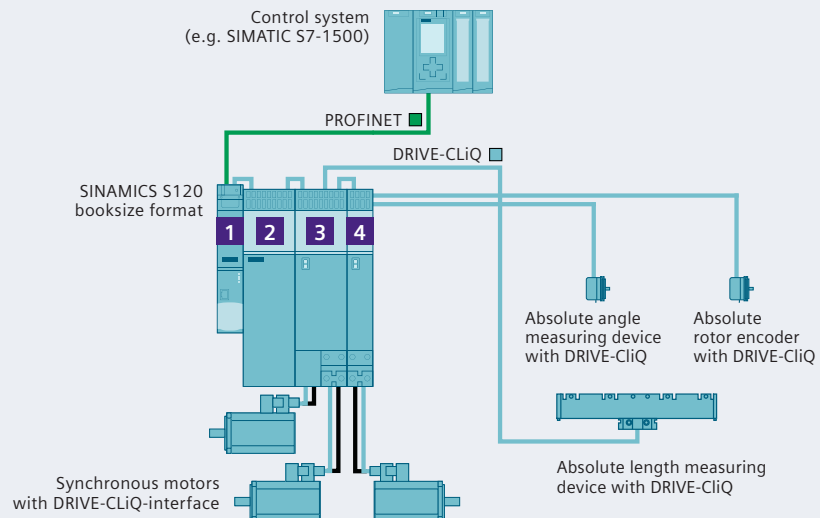

## | SIZER, DT Configurator and CAD CREATOR

With Siemens, you can obtain the optimum motor solution in a convenient and user-friendly way—thanks to the efficient and high-performance DT Configurator and CAD CREATOR tools for engineering and design.

### Drive engineering—easy and fast

#### Efficient motor selection and dimensioning— SIZER engineering software

The SIZER engineering software supports you when engineering a complete drive system, including options, accessories and connection systems. SIZER allows you to easily handle single-motor drives up to complex multi-axis drives. Starting with the application, a motor Wizard supports you step-by-step when dimensioning the motor. The advantage of this approach is that SIZER not only provides a list of all the components with the various ordering information, but also allows motor data to be easily imported into the CAD CREATOR.

#### Selecting and configuring made easy by using the Drive Technology Configurator

The Drive Technology Configurator, or DT Configurator, supports you when selecting the ideal products for your application—from motors through drives including relevant options.

Comprehensive documentation—from data sheets through operating instructions up to 2D/3D dimension drawings and certificates—can also be called up. The components you selected can be directly ordered by transferring them into the Industry Mall shopping cart.

#### Integrated—mechanical design based upon CAD CREATOR

Technical data, dimension drawings and CAD motor data can be quickly and easily generated using CAD CREATOR. The data can be simply transferred into the system documentation and used for the mechanical design. CAD CREATOR is included in the SIZER engineering software.



#### Online drive engineering tools

 [siemens.com/sizer](https://www.siemens.com/sizer)

 [siemens.com/dt-configurator](https://www.siemens.com/dt-configurator)

 [siemens.com/cad-creator](https://www.siemens.com/cad-creator)



# I Mechatronic Support

With Mechatronic Support, Siemens can offer you the ideal basis to significantly optimize the productivity and precision of your machine—and this, already in the design phase. As a result, new machine concepts can be virtually compared with one another, modified and optimized—without having to build a prototype.

## Faster to the machine—faster to market

### A clever alternative to trial and error



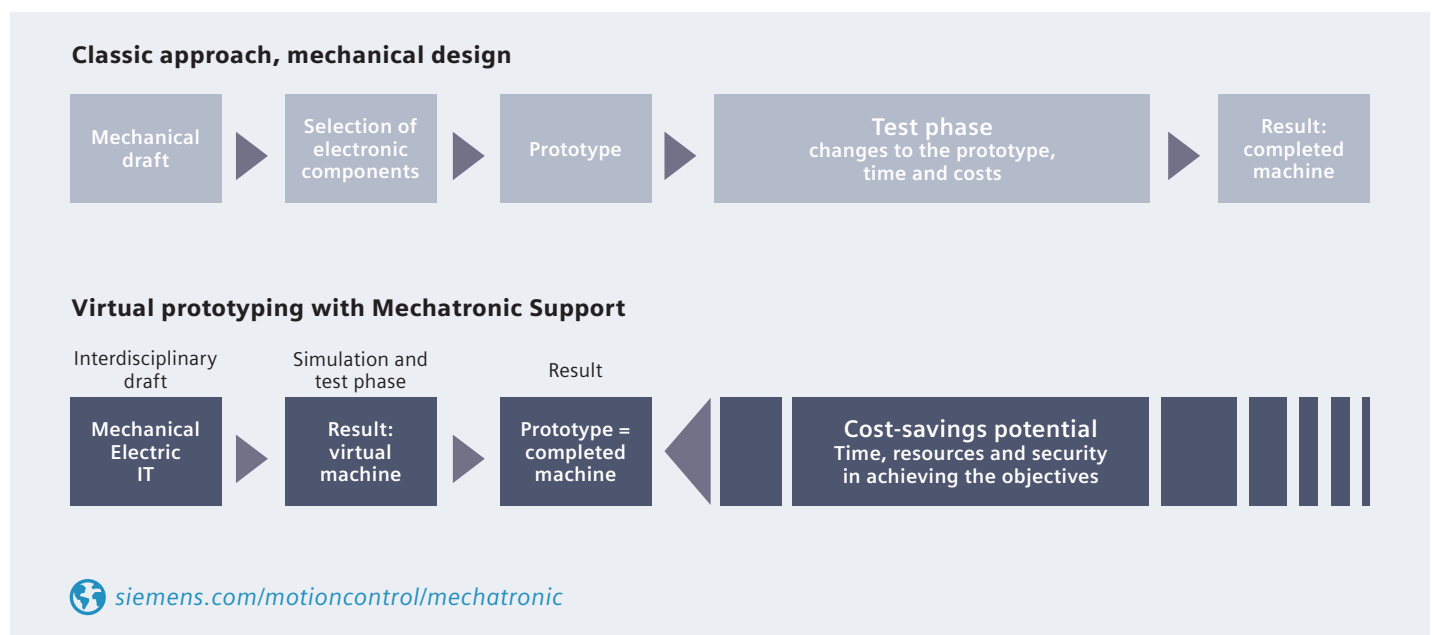

With Mechatronic Support, Siemens offers you an intelligent alternative to developing costly prototypes. Using virtual prototyping, already in the draft phase, all mechanical, electronic and IT systems can be modeled and optimized regarding their functionality. The machine is produced without having to build a prototype first.

### Siemens—your partner for machine development

- Comparison and assessment of machine concepts regarding static and dynamic precision, control loop dynamics, stiffness
- Mechatronic model building and machine simulation (finite element techniques)
- Computer-based optimization of machine structures
- Optimum dimensioning and selection of all motor and control loop components
- Commissioning and control loop optimization
- Analysis and optimization of existing tool and production machines locally on-site
- Shorter development times—faster to market
- Development objectives are reliably reached
- Risk-free testing of new machine concepts
- Higher quality and productivity from the start

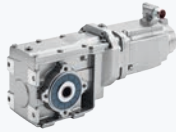

# SIMOTICS motion control motors—an overview

SIMOTICS				
	S-1FK7	S-1FT7	S-1FG1	S-1FL6
Servomotors			Servo-drive systems	
Cooling method				
Natural cooling	Yes	Yes	Yes	Yes
Forced-ventilated	Yes	Yes	—	—
Water-cooled	—	Yes	—	—
Open-circuit-cooled	—	—	—	—
Shaft height	20 ... 100	36 ... 132	29...109	20 ... 90
Degree of protection	IP64 to IP65	IP64 to IP67	IP65	IP65
Rated speed / velocity	2,000 ... 6,000 rpm	1,500 ... 6,000 rpm	13 ... 1,279 rpm	2,000 ... 5,000 rpm
Rated power	0.05 ... 8.17 kW	0.88 ... 45.5 kW	0.5 ... 1.8 kW	0.05 ... 7.0 kW
Rated Nm torque / force	0.08 ... 37 Nm	1.4 ... 250 Nm	up to 3,070 Nm <sup>1)</sup>	0.16 ... 33.4 Nm
Encoder				
Single-turn absolute	Yes	Yes	Yes	Yes
Multi-turn absolute	Yes	Yes	Yes	Yes
Incremental	Yes	Yes	—	Yes
Resolver	Yes	—	Yes	—
External required	—	—	—	—
Holding brake as option	Yes	Yes	Yes	Yes
Drive systems	SINAMICS S120	SINAMICS S120	SINAMICS S120	SINAMICS V90
Catalogs				
D21.4 SINAMICS S120 and SIMOTICS	Yes	Yes	—	—
D31.1 SINAMICS drives for single axis drives / built-in units	Yes	Yes	—	—
D32 SINAMICS S210 servo-drive systems	—	—	—	—
D33 SINAMICS V90 basis servo-drive system	—	—	—	Yes
D41 SIMOTICS S-1FG1 servo geared motor	—	—	Yes	—
NC62 SINUMERIK CNC systems for machine tools	Yes	Yes	—	—

<sup>1)</sup> Dependent upon the geared motor

 S-1FK2/1FT2/1FS2	 M-1PH8	 M-1FE1, M-1FE2	 L-1FN3	 T-1FW3	 T-1FW6
Main motors		Linear motor		Torque motors	
Yes	—	—	—	—	Yes
—	Yes	—	—	—	—
—	Yes	Yes	Yes	Yes	Yes
—	Yes	—	—	—	—
20 ... 100	80 ... 355	40 ... 180	—	150 ... 280	159 ... 730 <sup>4)</sup>
IP64 to IP67	IP23, IP55, IP65	IP00	IP65	IP54/IP55	IP23
3,000 rpm	400 ... 10,000 rpm	500 ... 25,000 rpm	up to 836 m/min <sup>2)</sup>	150 ... 1,200 rpm	38 ... 940 rpm
0.05 ... 7.5 kW	2.8 ... 1,340 kW	4.0 ... 159 kW	1.7 ... 81.9 kW	2.8 ... 380 kW	1.7 ... 54.1 kW
0.16 ... 34.5 Nm	2.9 ... 12,435 Nm	up to 1,530 Nm	150 ... 10,375 N <sup>3)</sup>	100 ... 7,000 Nm	10 ... 5,760 Nm
Yes	—	—	—	Yes	—
Yes	Yes	—	—	Yes	—
—	Yes	—	—	Yes	—
—	—	—	—	Yes	—
—	—	Yes	Yes	—	Yes
Yes	Yes	—	—	—	—
SINAMICS S210	SINAMICS S120, G120	SINAMICS S120	SINAMICS S120	SINAMICS S120	SINAMICS S120
—	Yes	—	Yes	Yes	Yes
—	Yes	—	—	—	—
Yes	—	—	—	—	—
—	—	—	—	—	—
—	—	—	—	—	—
—	Yes	Yes	Yes	—	Yes

<sup>2)</sup> Maximum velocity at rated force (feed force  $F_N$ )

<sup>3)</sup> Rated force (feed force  $F_N$ )

<sup>4)</sup> Outer stator diameter

**Published by  
Siemens Industry, Inc.**

100 Technology Drive  
Alpharetta, GA 30005

(770) 871-3800

Order No. DRBR-SIMOTICS-0822

Printed in USA

© 08.2022 Siemens Industry, Inc.

[usa.siemens.com/motioncontrol](http://usa.siemens.com/motioncontrol)

This brochure contains only general descriptions or performance features, which do not always apply in the manner described in concrete application situations or may change as the products undergo further development. Performance features are valid only if they are formally agreed upon when the contract is closed.

Siemens is a registered trademark of Siemens AG. Product names mentioned may be trademarks or registered trademarks of their respective companies.

Specifications are subject to change without notice.